



HID-A-BAG

“THE INDUSTRY STANDARD”



QUOTE

HAUL-ALL EQUIPMENT LTD WASTE & RECYCLING SOLUTIONS

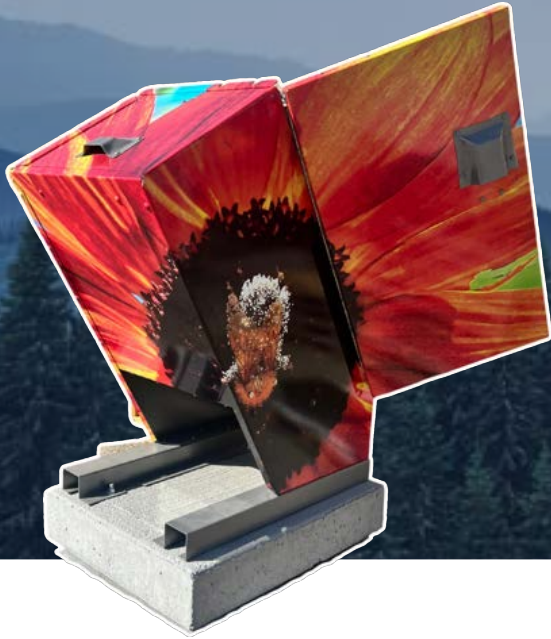

Haul-All Equipment specializes in the design, manufacture, sale and support of waste and recycling systems including storage containers, collection vehicles and transfer stations.

40+ years experience
30+ Patents & Trademarks
IGBC Certified Products

Our focus is on delivering high-quality products and pioneering advancements in the industry.

THE HID-A-BAG:

CERTIFIED BEAR, ANIMAL & CRITTER RESISTANT BINS

It was the industry's first bear-resistant container designed with a self-closing lid and bear resistant latch to eliminate the food reward that would come from breaching a container along park trails and remote wilderness locations.

The Hid-A-Bag has become an iconic symbol of parks and recreation in shared wilderness locations across Canada and the U.S.

Trust in Haul-All for unparalleled quality in waste and recycling bins, harnessing the most effective bear-resistant technologies available.

Today, the Hid-A-Bag is more than a product for bear resistant applications.

TRUSTED BY



BCParks





HID-A-BAG

The Hid-A-Bag is manufactured from galvanized steel, which is more resistant to scratching and damage during manufacturing, with stainless steel hinges to resist corrosion. The container is primed and painted with powder coat for a thick, dense finish, which is more durable and long lasting than liquid paint, and riveted together to maximize service life.

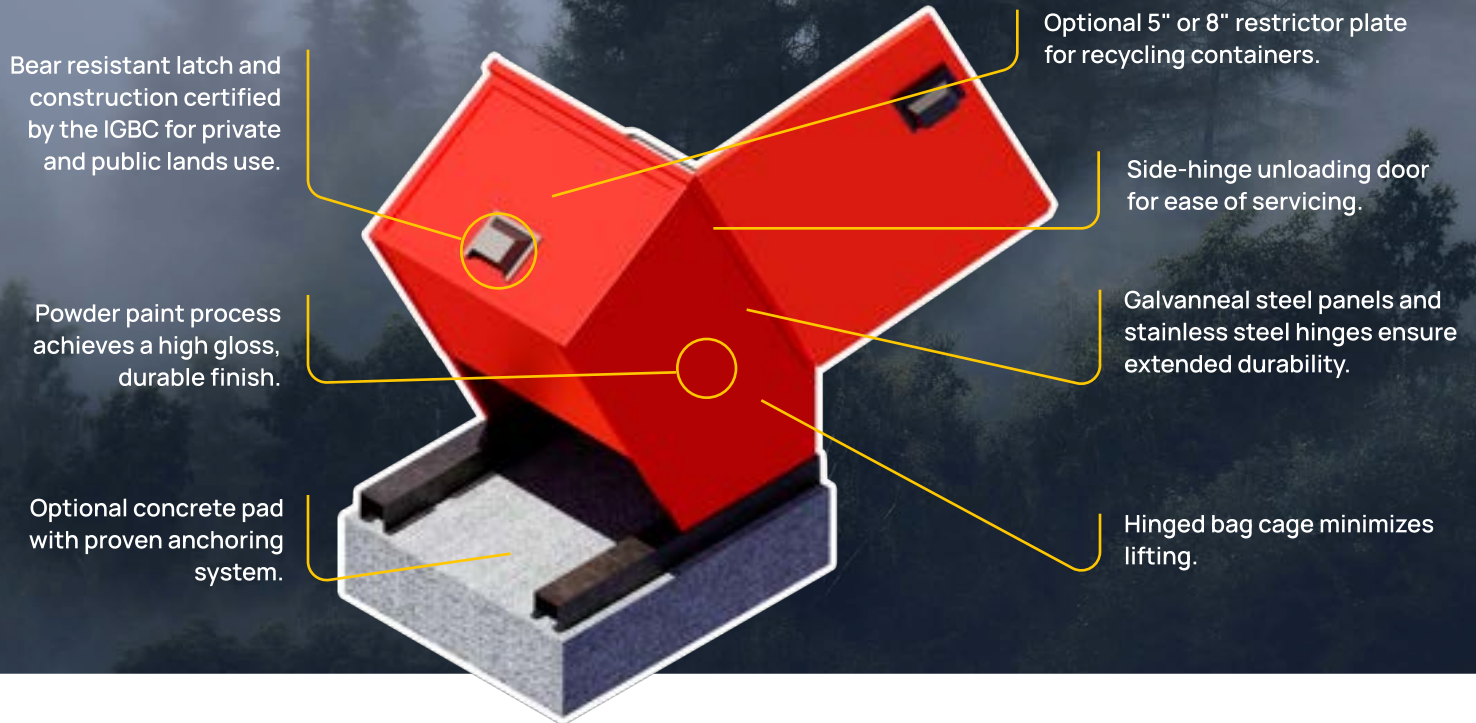

MODEL VARIANTS

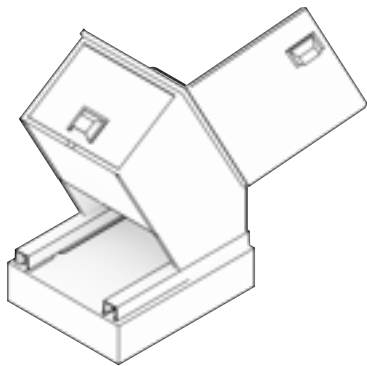

Hid-A-Bag I

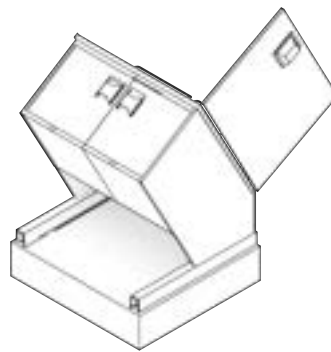

Hid-A-Bag II

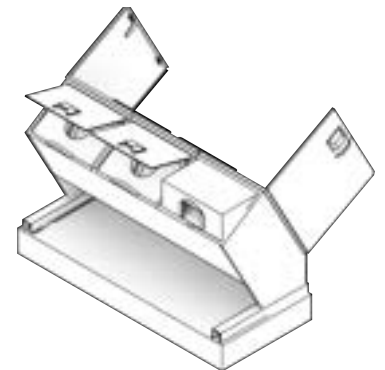

Hid-A-Bag III



QUOTE

DISCOVER THE FEATURES THAT MAKE **HID-A-BAG** YOUR BEST CHOICE!



IGBC BEAR RESISTANT CERTIFIED



RECYCLING RESTRICTOR PLATE



POLY WOOD SIDING



VINYL GRAPHICS WRAP



CUSTOM DECALS



KEY SLOT LOCK ON UNLOAD DOOR



POLY LINER



CONCRETE MOUNTING PAD

STOCK COLOURS



● Neufeldt Green

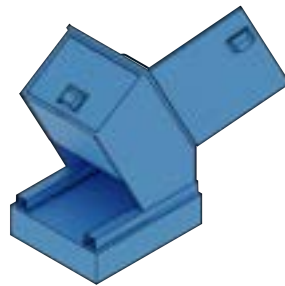

● Grabber Blue



● Forest Green



● Orange



● Baron Red

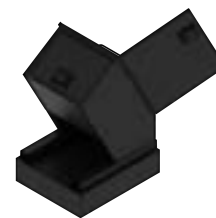

● Black



● Pewter



QUOTE

SPECIFICATIONS

HBIS HID-A-BAG I

CAPACITY	HEIGHT	LENGTH	WIDTH	CONSTRUCTION	HINGES & LATCHES	PAINT	WEIGHT	WEIGHT (PRECAST MOUNTING PAD)
265 L (9-1/2 cu.ft. / 70 US Gallons)	1245 mm (49 inches)	1067 mm (42 inches)	710 mm (28 inches)	Galvanneal Steel	Stainless Steel	Powder Coat	100 kg (220 lbs)	155 kg (345 lbs)

HBIM MINI HID-A-BAG I

120 L (4.2 cu.ft. / 32 US Gallons)	1090 mm (43 inches)	865 mm (34 inches)	535 mm (21 inches)	Galvanneal Steel	Stainless Steel	Powder Coat	73 kg (160 lbs)	136 kg (300 lbs)
---------------------------------------	------------------------	-----------------------	-----------------------	------------------	-----------------	-------------	--------------------	---------------------

HBIIS HID-A-BAG II

500 L (17.7 cu.ft. / 132 US Gallons)	1245 mm (49 inches)	1064 mm (42 inches)	1220 mm (48 inches)	Galvanneal Steel	Stainless Steel	Powder Coat	150 kg (325 lbs)	270 kg (595 lbs)
--------------------------------------	------------------------	------------------------	------------------------	------------------	-----------------	-------------	---------------------	---------------------

HBIIM MINI HID-A-BAG II

225 L (8 cu.ft. / 60 US Gallons)	1090 mm (43 inches)	865 mm (34 inches)	965 mm (38 inches)	Galvanneal Steel	Stainless Steel	Powder Coat	109 kg (240 lbs)	180 kg (395 lbs)
-------------------------------------	------------------------	-----------------------	-----------------------	------------------	-----------------	-------------	---------------------	---------------------

HB3S HID-A-BAG III

740 L (26 cu.ft. / 195 US Gallons)	1245 mm (49 inches)	1067 mm (42 inches)	1780 mm (70 inches)	Galvanneal Steel	Stainless Steel	Powder Coat	204 kg (450 lbs)	454 kg (1000 lbs)
---------------------------------------	------------------------	------------------------	------------------------	------------------	-----------------	-------------	---------------------	----------------------

HB3M MINI HID-A-BAG III

360 L (12.7 cu.ft. / 95 US Gallons)	1090 mm (43 inches)	865 mm (34 inches)	1398 mm (55 inches)	Galvanneal Steel	Stainless Steel	Powder Coat	145 kg (320 lbs)	272 kg (600 lbs)
-------------------------------------	------------------------	-----------------------	------------------------	------------------	-----------------	-------------	---------------------	---------------------

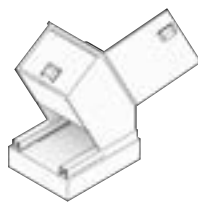

**CONTACT OUR TEAM
FOR TAILORED ADVICE & PRICING**

1-888-428-5255

SALES@HAULALL.COM

BOOK A CALL

REQUEST A QUOTE

